

0.500 (12.7) milled off top and bottom

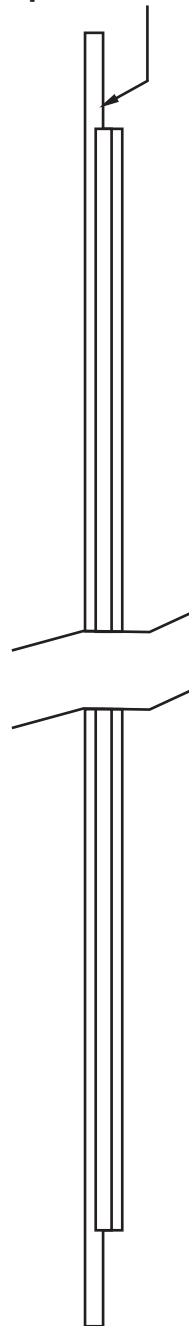

Extruded Profile for metal clip (C) style gasket.

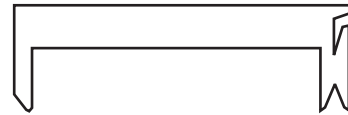

Extruded Profile for Spira, aluminum wrapped silicone gasket

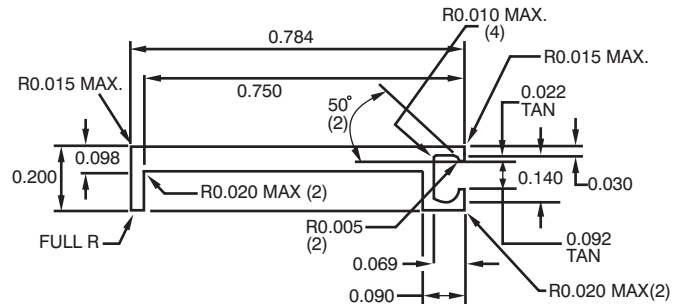

Detail A

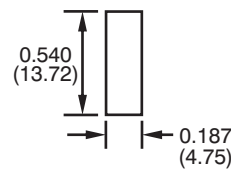

Detail B

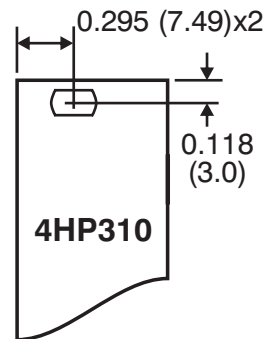
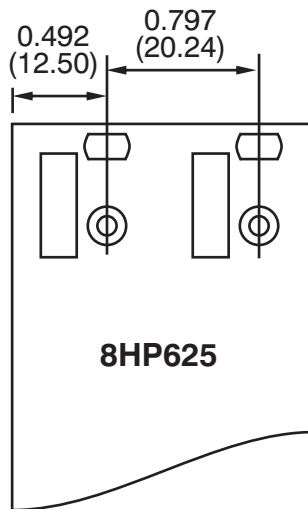
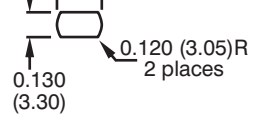

P/N	A	B
4HP3 series	5.060	0.784
4HP6 series	10.309	0.784
8HP3 series	5.060	1.588
8HP6 series	10.309	1.588
12HP3 series	5.060	2.384
12HP6 series	10.309	2.384

MATERIAL: Brushed Aluminum 6063/T6
 Trivalent Chem-Film plated or clear Anodized.
 RoHS compliant.
MATERIAL THICKNESS: 0.098